

Construction characteristics

Cover plates	UNI 5079 aluminium alloy casting
Central body	oxidised aluminium
Pinion	18 NiCrMo4 cemented and tempered
Rack	C43
Barrel	anodised aluminium Ra=0.3-0.5
Sliding shoe	acetal resin
Cushion bushings	hardened aluminium
Piston	vulcanized rubber block on steel core with incorporated permanent magnet or without magnet plus rear spacer for non magnetic version
Seals	NBR 80 shore rubber
Cushion adjustment screw	nickel plated steel
Rotating angle adjustment assy	nickel plated brass

Technical characteristics

Fluid	filtered and preferably lubricated air
Max. pressure	10 bar
Working temperature	-5°C- +70°C
Standard rotation	90° - 180° - 270° - 360°(+1°)
Rotating angle adjustment assy	±10°

Please follow the suggestions below to ensure a long life for these cylinders:

- use clean and lubricated air
- correct alignment during assembly with regard to the applied load so as to avoid radial components or bending the rod.
- avoid high speeds together with long strokes and heavy loads: this would produce kinetic energy which the cylinder cannot absorb, especially if used as a limit stop (in this case use mechanical stop device)
- evaluate the environmental characteristics of cylinder used (high temperature, hard atmosphere, dust, humidity etc.)

Please note: air must be dried for applications with lower temperature.

Use hydraulic oils H class (ISO Vg32) for correct continued lubrication.

Our Technical Department will be glad to help.

Bore	32	40	50	63	80	100
Torque moments Nm/bar	0.9	1.7	2.9	5.55	13.2	23.8
Axis load max. kg.	8	10	10	12	18	22
Cushioning angle	60°	60°	50°	50°	40°	40°

Female pinion version

Ordering code

- 1330.Ø.*.01**
magnetic
 - 1331.Ø.*.01**
non magnetic
 - 1330.Ø.*.01R**
magnetic with
rotating adjustment
angle
 - 1331.Ø.*.01R**
non magnetic with
rotating adjustment
angle
- * = rotating angle

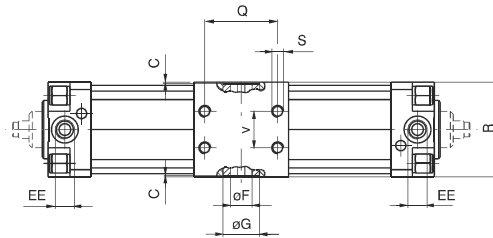
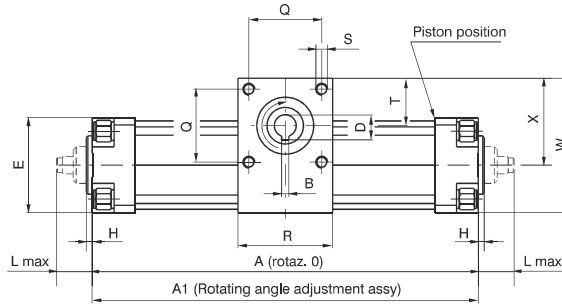
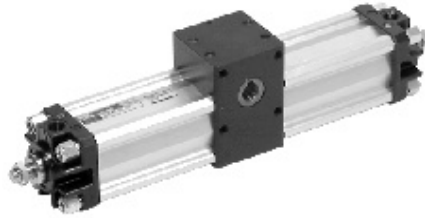

Male pinion version

Ordering code

- 1332.Ø.*.01**
magnetic
 - 1333.Ø.*.01**
non magnetic
 - 1332.Ø.*.01R**
magnetic with
rotating adjustment
angle
 - 1333.Ø.*.01R**
non magnetic with
rotating adjustment
angle
- * = rotating angle

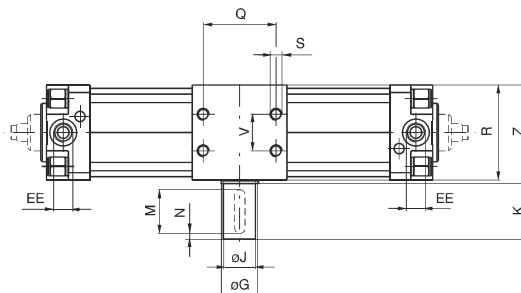
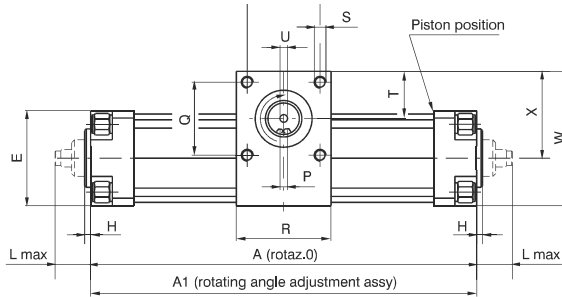

Dimensions

Bore	32	40	50	63	80	100	
A rot. 0°	171	195	202	233	268	300	
A rot. 90°	218	252	265	308	378	427	
A rot. 180°	265	308	328	382	488	555	
A rot. 270°	312	364	390	457	598	682	
A rot. 360°	359	421	453	531	708	809	
A1 rot. 0°	174	198	206	237	274	307	
A1 rot. 90°	221	255	269	312	384	434	
A1 rot. 180°	268	311	332	386	494	562	
A1 rot. 270°	315	367	394	461	604	689	
A1 rot. 360°	362	424	457	535	714	816	
B	5	5	5	6	6	8	
C	1	1	1	1	1	1	
D	17.3	17.3	17.3	20.8	22.8	28.3	
E	46	52	65	75	95	115	
Ø F (H 7)	15	15	15	18	20	25	
Ø G	25	25	25	30	40	55	
H	4	4	4	4	4	4	
Ø J (h 7)	14	14	22	25	30	35	
K	30	30	40	40	50	50	
L max.	23	23	28.5	28.5	34.5	34.5	
M	25	25	35	35	45	45	
N	2.5	2.5	2.5	2.5	2.5	2.5	
P	5	5	6	8	8	10	
Q	33	40	50	60	80	80	
R	50	60	65	75	100	115	
S	M6	M6	M8	M8	M10	M10	
T	27.5	35	32.5	35.5	50	54.5	
U	M5	M5	M6	M8	M8	M10	
V	18	22	25	35	50	60	
W	71	85	92	105	141	162	
X	48	59	59.5	67.5	93.5	104.5	
Z	51	61	66	76	101	116	
EE	G 1/8"	G 1/4"	G 1/4"	G 3/8"	G 3/8"	G 1/2"	
Piston stroke every 10 ° of rotation	2.61	3.14	3.49	4.14	6.11	7.07	
Female Pinion weight gr.	rot. 90°	1450	2020	3050	4850	10000	14900
	rot. 180°	1600	2240	3350	5350	11000	16350
	rot. 270°	1750	2460	3650	5850	12000	17800
	rot. 360°	1900	2680	3950	6350	13000	19250
Male Pinion weight gr.	rot. 90°	1550	2150	3280	5150	10500	15700
	rot. 180°	1700	2370	3580	5650	11500	17150
	rot. 270°	1850	2590	3880	6150	12500	18600
	rot. 360°	2000	2810	4180	6650	13500	20050

Magnetic sensors

Sensors 1500._, RS._, HS._ series
 Mounting brackets codes 1320._(A, B, C)

Sensor brackets

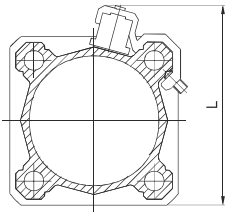

Sensor brackets codes 1500._, RS._, HS._			Sensor brackets codes 1580._, MRS._, MHS._		
Code	Bore	L	Code	Bore	L1
1320.A	Ø32	60	1320.AS	Ø32	48
	Ø40	65		Ø40	54
1320.B	Ø50	77	1320.BS	Ø50	66
	Ø63	87		Ø63	76
	Ø80	105		Ø80	96
1320.C	Ø100	125	1320.CS	Ø100	112
	Ø125	145		/	/
1320.D	Ø160	184	/	/	/
1320.E	Ø200	222	/	/	/
1320.F			/	/	/

for cylinders: 1319 - 1320, 1325 - 1345, 1330 - 1332, 1348 - 1349

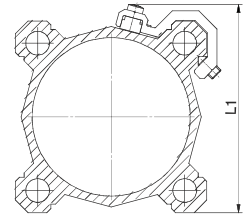

Sensor for microcylinders

For technical characteristics and ordering codes see Chapter 6 (magnetic sensors)

Distributor supports

This accessory permits to mount a valve or an electrovalve on a side of the cylinder. The plate can be fitted on the cylinder profiled barrel, and, on it, can be mounted either a threaded distributor or a base on which can be mounted an ISO distributor. Once installed the connections must be done with fittings and pipes. All of the threaded holes on the support plate are dedicated to different valves series as per attached drawing.

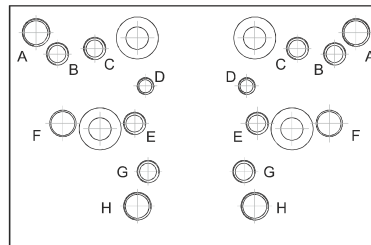

Fixing holes for valves series:

- A = 414/2
- B = 824
- C = 828, T488, 488, 484
- D = 2400
- E = 2600
- F = Bases for ISO distributors
- G = 858/2
- H = T424

For cylinders series 1319 - 1321 / 1325 - 1326 / 1345 - 1347 / 1330 - 1333 / 1348 - 1350

Ordering code

- 1320.15** (Ø32 - Ø40)
- 1320.16** (Ø50 - Ø63)
- 1320.17** (Ø80 - Ø100)
- 1320.18** (Ø125)
- 1320.19** (Ø160)
- 1320.20** (Ø200)

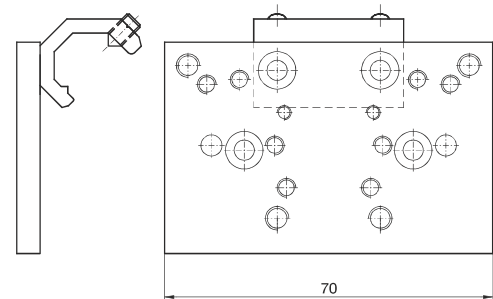

Bases for ISO distributors

Ordering code

- 1320.21** bases for ISO 1 electro distributor
- 1320.22** bases for ISO 2 electro distributor

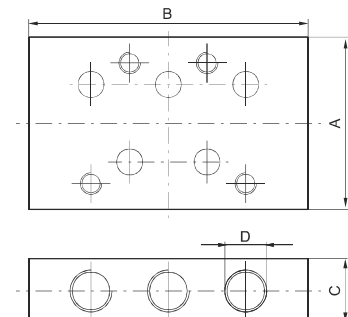
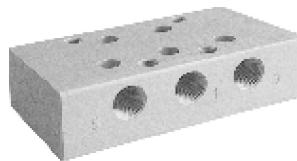

Dimensions

		A	B	C	D
1320.21	bases for ISO 1 electro distributor	40	75	15	G 1/8"
1320.22	bases for ISO 2 electro distributor	50	95	20	G 1/4"