

Sensor brackets codes 1600._, SRS._, SHS._

Ordering code
1600.A

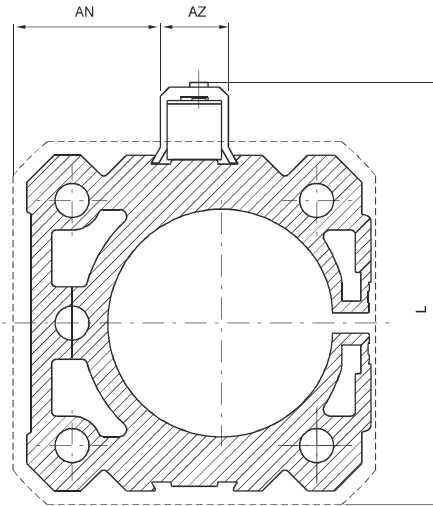
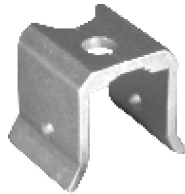

Bore	25	32	40	50	63
AN	12,5	20	25	32,5	40
AZ	15	15	15	15	15
L	55	68	79	94	110
LB	45	58	69	84	100
Weight gr.	1600.A	3	3	3	3
	1600.B	1	1	1	1

Sensor brackets codes 1580._, MRS._, MHS._

Ordering code
1600.B

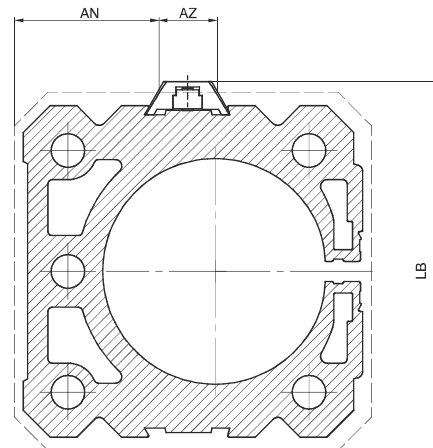

Sensors

For technical characteristics and ordering codes see Chapter 6 (magnetic sensors)

Instruction on how to use the sensors properly

Particular attention must be paid not to exceed the working limits listed in the tables and that the sensor is never connected to the mains without a load connected in series; these are the only measures that if not observed can put the circuits out of order. In the case of direct current (D.C.) connection polarities must be respected, that is the brown wire to the positive load (+) and the blue to the negative (-). If these are inverted the sensor remains switched, the load connected and the led turned off. However, this would not damage the circuit.

For the "U" type sensors attention must be paid that the length of the cable doesn't exceed 8 metres, with tension above 100 V. In this case a serial resistance is added to reduce the cumulative effects of the line. As an example 1000 W per 100-130 V e 2000 W per 200-240 V.

Mounting foot brackets

Ordering code

1600.Ø.01F (1 piece)

**Bore
25 - 32**

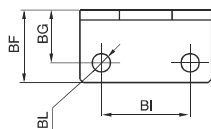
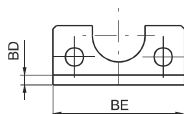
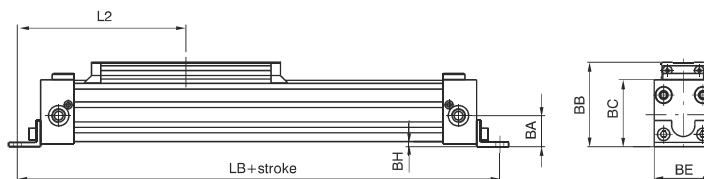

Bore	25	32	40	50	63
BA	21,5	28	32,5	41	49
BB	58	72,5	81,5	100	116
BC	46	57,5	66,5	82	97,5
BD	3	3	20	25	30
BE	40	55	65	80	95
BF	22	25	25	25	30
BG	16	18	12,5	12,5	15
BH	3,5	6	4,5	5	5
BI	27	36	30	40	48
BL	5,5	6,6	9	9	11
L2	116	143	162,5	187,5	230
LB	232	286	32,5	375	460
Weight gr.	30	45	65	110	190

4



**Bore
40 - 50 - 63**

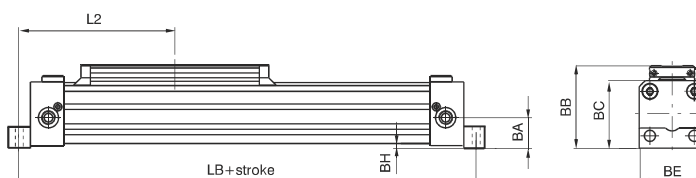
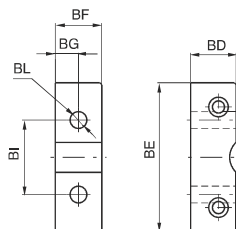

Intermediate support

Ordering code

1600.Ø.02F

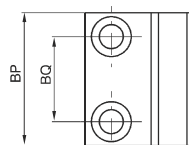
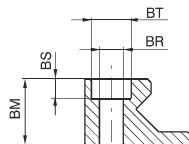
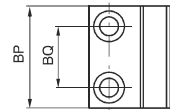
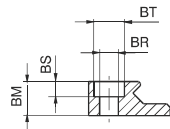
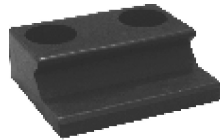

**Bore
25 - 32**

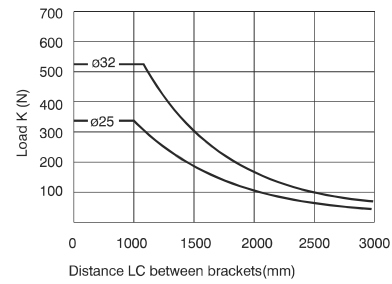
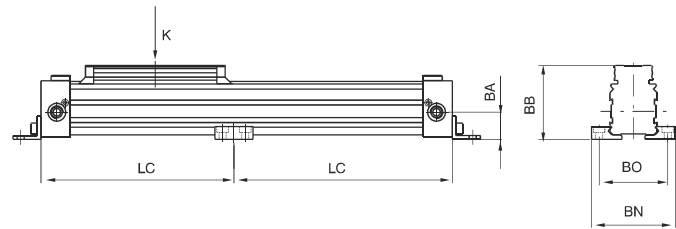

Bore	25	32	40	50	63
BA	21,5	28	32,5	41	49
BB	58	72,5	81,5	100	116
BM	10	18	18	25	30
BN	66	86	96	120	140
BO	54	70	80	100	120
BP	30	40	40	50	50
BQ	18	25	25	32	32
BR	5,5	6,6	6,6	9	9
BS	4,5	5,5	5,5	7,5	7,5
BT	9	11	11	15	15
Weight gr.	25	80	80	160	215

**Bore
40 - 50 - 63**

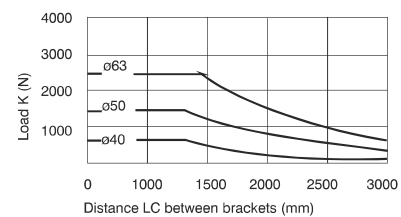
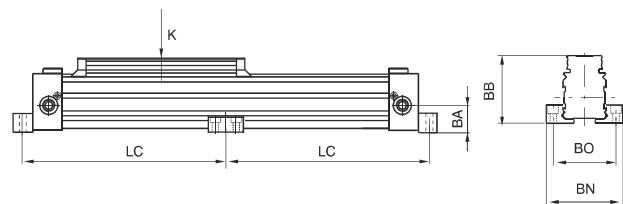

Oscillating hinge

Ordering code

1600.Ø.03F

Bore
25 - 32 - 40

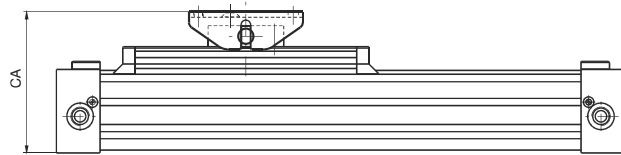
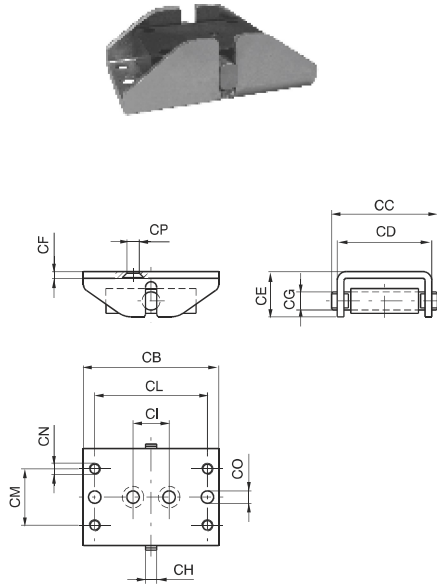

Bore	25	32	40	50	63
CA (±5.5)	76	99.5	108.5	135.5	151
CB	60	100	100	120	120
CC	47	64	64	92	92
CD (±5)	42	56	56	80	80
CE	20	30	30	42	42
CF	3	4	4	6	6
CG	8	12	2	16	16
CH	5	8	8	10	10
CI	16	40	40	65	65
CL	50	80	80	100	100
CM	25	30	30	47	47
CN	M5	M6	M6	M8	M8
CO	5.5	6.5	6.5	9	9
CP	5.5	7	7	-	-
Weight gr.	130	380	380	990	990

Bore
50 - 63

